

# PANIC EXIT DEVICE

## INSTALLATION INSTRUCTION

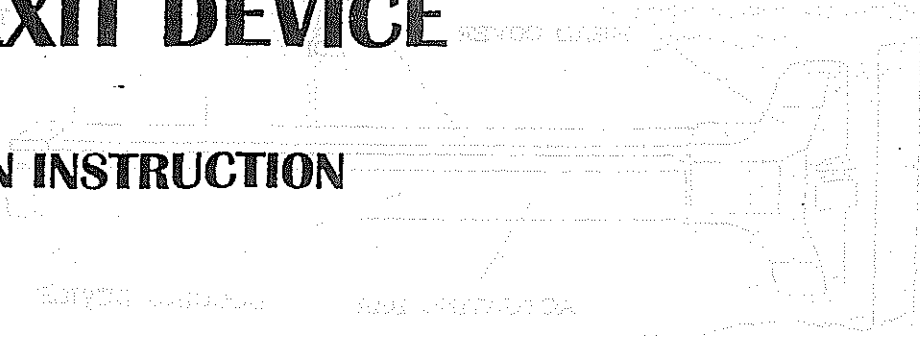

HANDLE

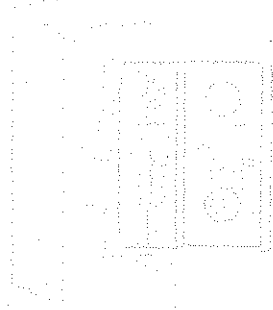

DEVICE BODY



LATCH

FRONT SIDE FLANGE

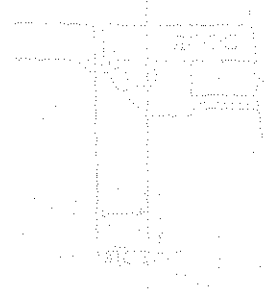

REAR SIDE FLANGE



INSTALLATION TO BODY



FRONT SIDE FLANGE

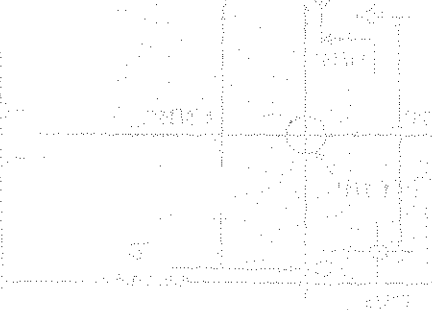

REAR SIDE FLANGE



1. THE HANDLE IS ATTACHED TO THE FRONT SIDE FLANGE BY THE SCREWS PROVIDED WITH THE HANDLE.

2. THE DEVICE BODY IS ATTACHED TO THE REAR SIDE FLANGE BY THE SCREWS PROVIDED WITH THE BODY.

# A IDENTIFICATION OF PARTS

IF DOOR IS LESS THAN 36",  
TAKE OFF END COVER AND  
CUT SECTION "A"  
TO REACH DESIRED  
TOTAL LENGTH

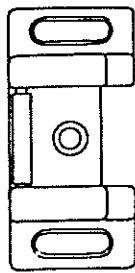
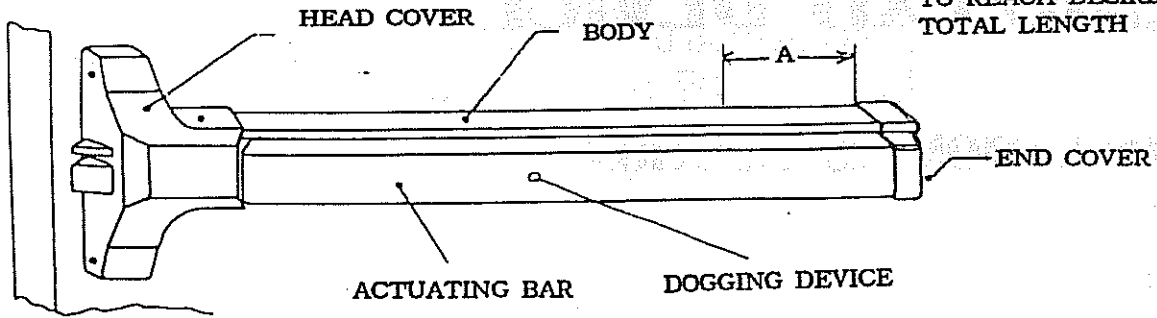

KEEPER

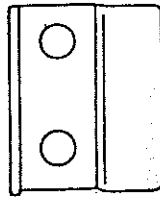

LINING-  
END COVER

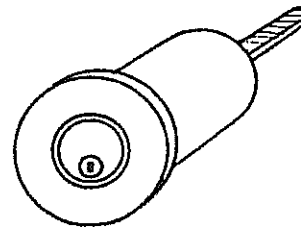

RIM CYLINDER

# B TYPE OF INSTALLATION

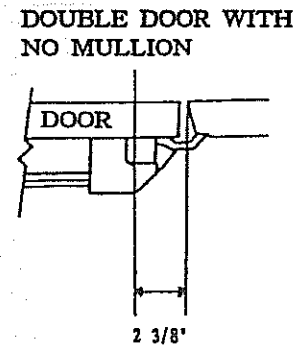
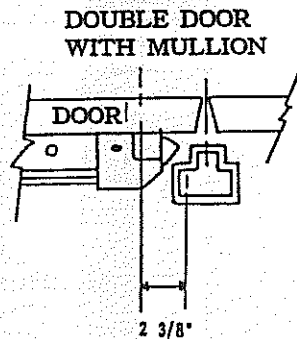
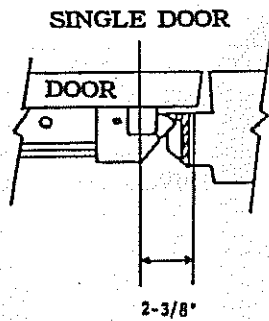

# C DRILL HOLES

1. USE TEMPLATE ENCLOSED TO MARK DOOR FACE AND DRILL HOLES IN ACCORDANCE WITH THE DIMETERS SUGGESTED

2. 'B' LENGTH SHOULD BE MEASURED FROM THE CENTER OF CYLINDER HOLE TO THE END OF THE BODY

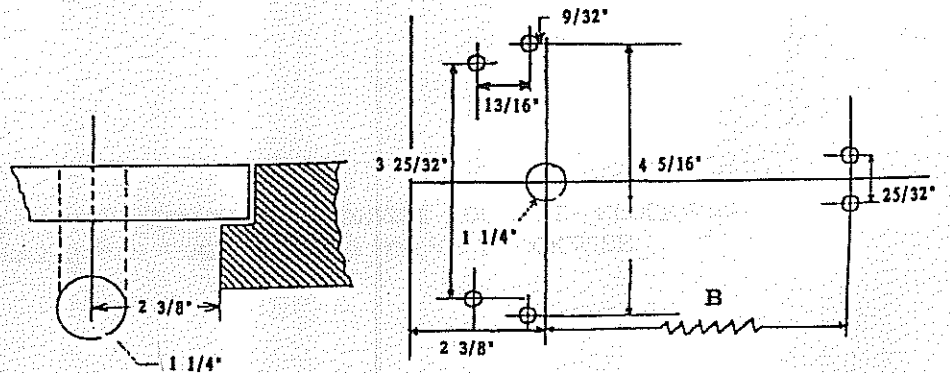

OUTSIDE FACE OF THE DOOR

INSIDE FACE OF THE DOOR

## D INSTALL KEY CYLINDER

OUTSIDE FACE OF THE DOOR

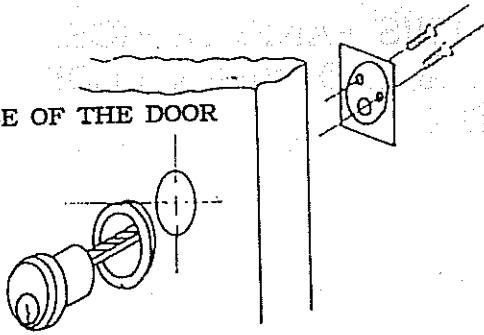

1. INSERT THE CYLINDER INTO THE HOLE ON THE DOOR
2. KEEP THE TAILPIECE HORIZONTAL
3. TIGHTEN THE SCREWS

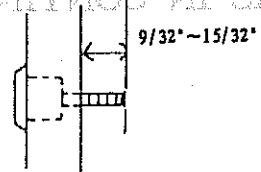

TAILPIECE PROJECTION

## E INSTALL BODY

1. REMOVE THE HEAD COVER AND THE SCREWS ON THE END COVER
2. ALIGN THE SCREW HOLES WITH THE HOLES ON THE DOOR
3. TIGHTEN THE SCREWS ON THE BODY AND THE LINING OF END COVER

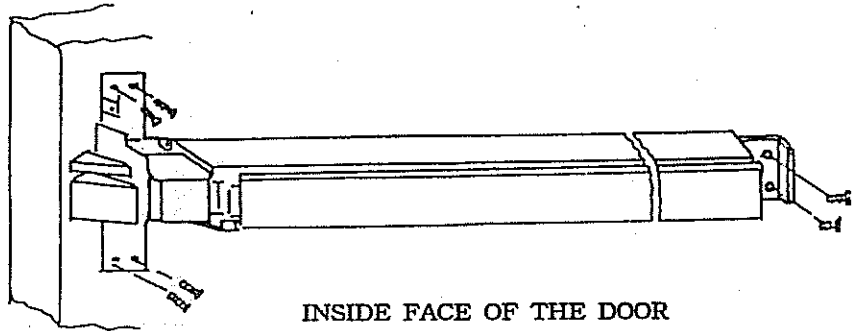

INSIDE FACE OF THE DOOR

## F PUT ON BOTH HEAD AND END COVER

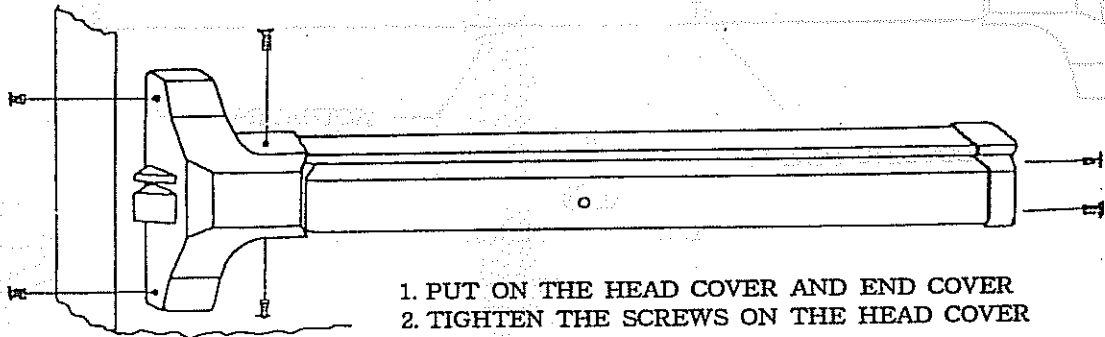

1. PUT ON THE HEAD COVER AND END COVER
2. TIGHTEN THE SCREWS ON THE HEAD COVER AND THE END OVER

## G OPERATION TEST

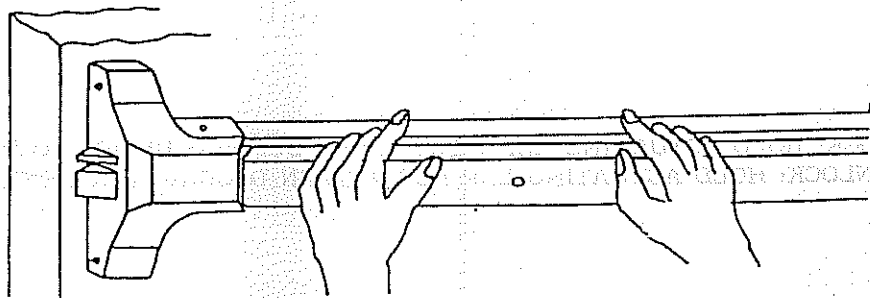

PRESS DOWN THE ACTUATING BAR. TRY TO OPEN AND CLOSE DOOR AFTER INSTALLATION COMPLETED

# NOTICE

TO EXTEND THE LIFE OF THIS PANIC DEVICE,  
LOCK THE LATCH AS RETRACTED WHEN DOOR  
IS IN CONTINUOUS ACTIVITY.

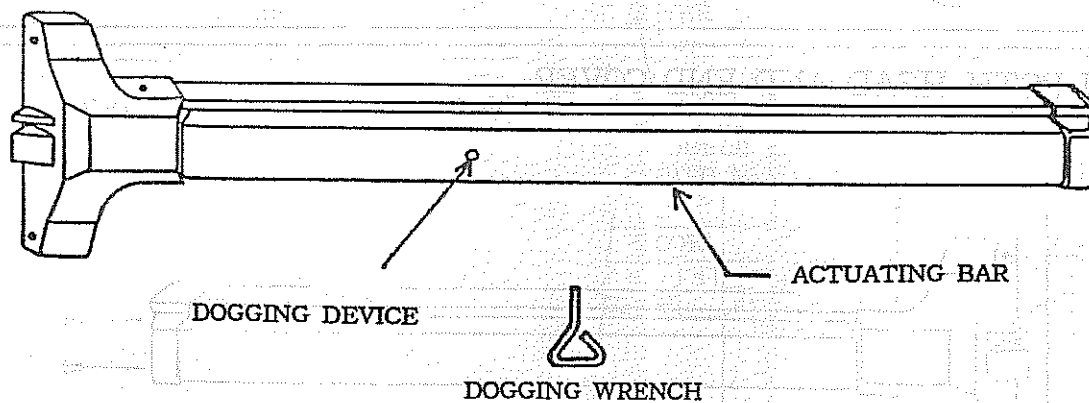

**TO LOCK: HOLD ACTUATING BAR DOWN. TURN DOGGING DEVICE COUNTER- CLOCKWISE.**  
**TO UNLOCK: HOLD ACTUATING BAR DOWN. TURN DOGGING DEVICE CLOCKWISE.**